

FEATURES

- * Schottky Barrier Chip
- * Guard Ring Die Construction for Transient Protection
- * Low Power Loss, High Efficiency
- * High Surge Capability
- * High Current Capability and Low Forward Voltage Drop
- * For Use in Low Voltage, High Frequency Inverters, Free Wheeling, and Polarity Protection Applications

PACKAGE

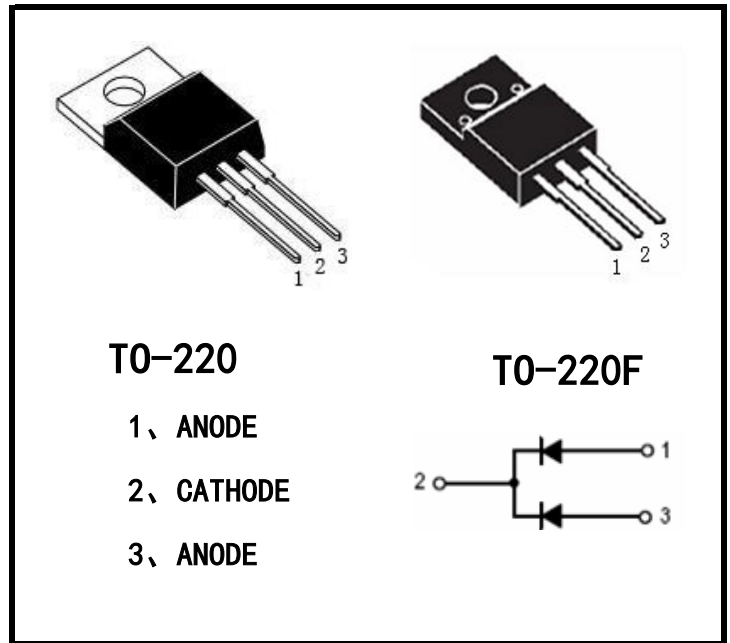

ELECTRICAL CHARACTERISTICS (T_{amb}=25°C)

Characteristic	Symbol	Value	Unit	
Peak Repetitive Reverse Voltage	V _{RRM}	45	V	
Working Peak Reverse Voltage	V _{RWM}			
DC Blocking Voltage	V _R			
Average Rectifide Output Current	I _{F(per leg)}	8	A	
	I _{F(Total)}	16		
Non-Repetitive Peak Surge Current (Surge applied at rated load conditions halfwave, single phase, 60Hz)	I _{FSM}	200	A	
Maximum Instaneous Forward Voltage @IF=8A, TC=25°C @IF=8A, TC=125°C	V _F	0.6	V	
		0.53		
Peak Reverse Current @Tc=25 °C at Rated DC Blocking Voltage @Tc=125°C	I _R	0.1	mA	
		15		
Operating and Storage Temperature Range	T _J , T _{STG}	-65 to +150	°C	
Maximum Thermal Resistance	θ _{JC}	T0-220	2.2	°C/W
		T0-220F	4.5	
	θ _{JA}	T0-220	60	
		T0-220F	60	

Characteristics Curves

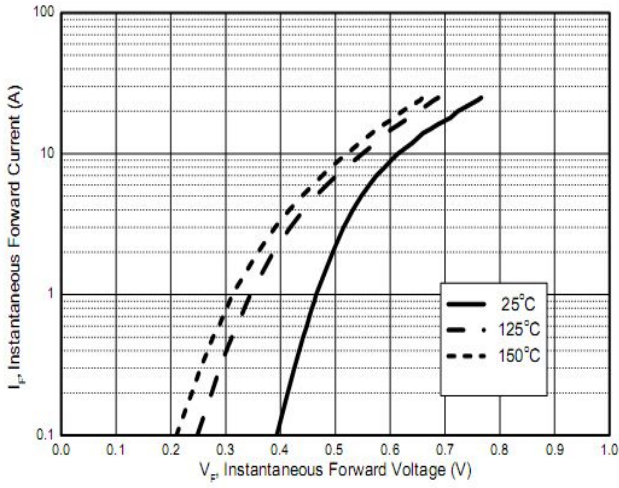

Typical Forward Voltage

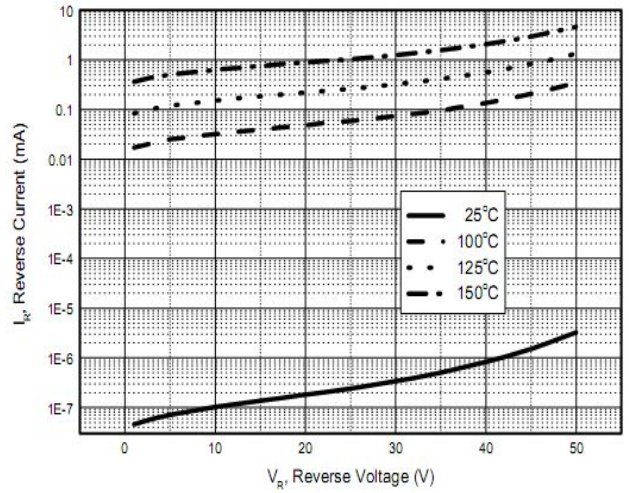

Typical Reverse Current

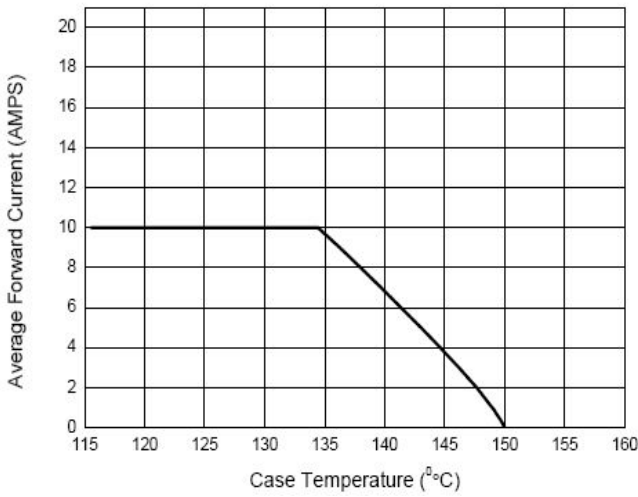

Average Forward Current vs. Case Temperature Per Diode

■ Reflow Soldering Temperature Profile

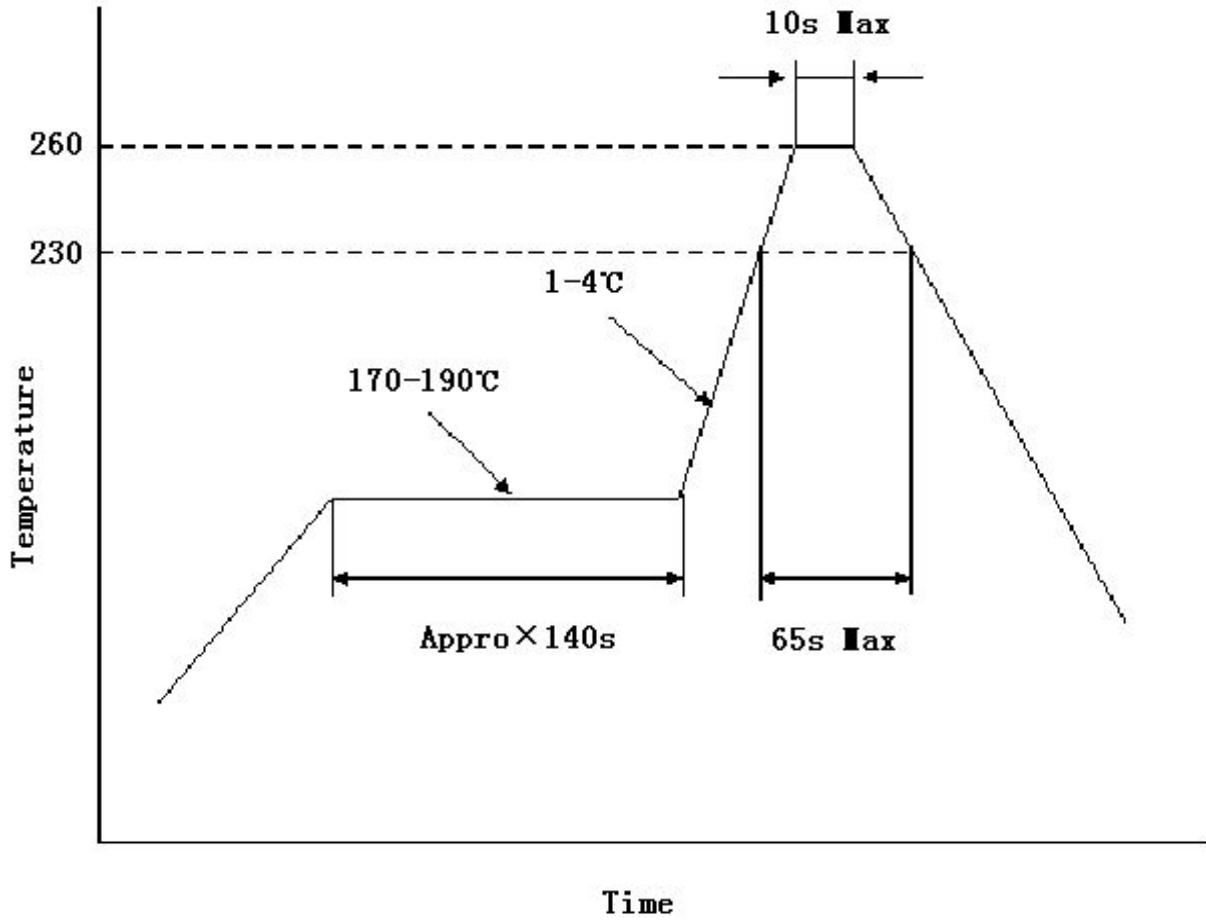

TO-220 MECHANICAL DATA

UNIT: mm

SYMBOL	MIN	NOM	MAX	SYMBOL	MIN	NOM	MAX
A	4		4.8	e	2.44	2.54	2.64
B	1.2		1.4	F	1.1		1.4
B1	1		1.4	L	12.5		14.5
b1	0.75		0.95	L1	3	3.5	4
c	0.4		0.55	ΦP	3.7	3.8	3.9
D	15		16.5	Q	2.5		3
D1	5.9		6.9	Q1	2		2.9
E	9.9		10.7				

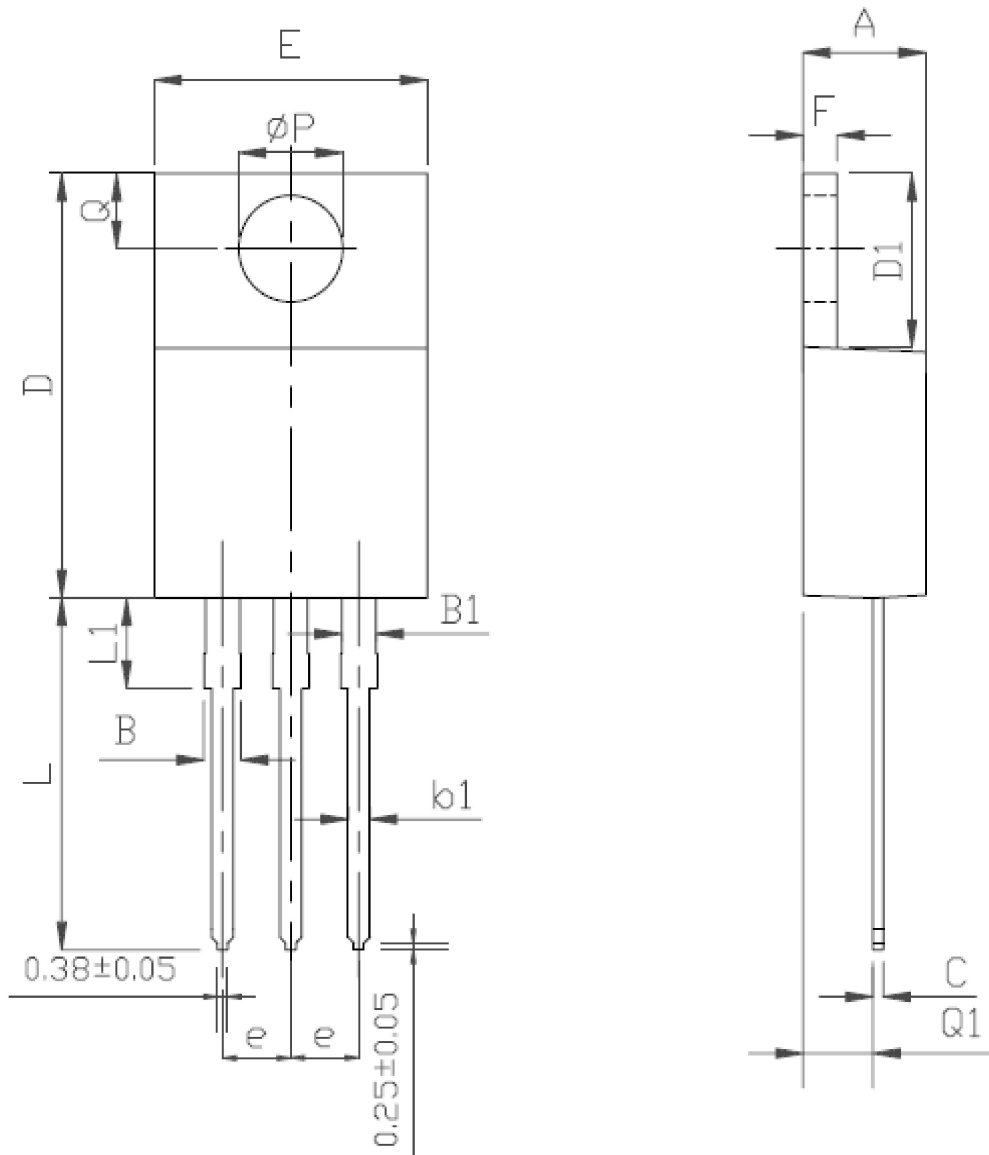

TO-220F MECHANICAL DATA

UNIT: mm

SYMBOL	MIN	NOM	MAX	SYMBOL	MIN	NOM	MAX
A	4.5		4.9	E1	6.5	7	7.5
A1	2.3		2.9	e	2.44	2.54	2.64
b	0.65		0.9	L	12.5		14.3
b1	1.1		1.7	L1	9.45		10.05
b2	1.2		1.4	L2	15		16
c	0.35		0.65	L3	3.2		4.4
D	14.5		16.5	ΦP	3		3.3
D1	6.1		6.9	Q	2.5		2.9
E	9.6		10.3				

