

DESCRIPTION

- ELECTRONIC BALLAST
- ELECTRONIC TRANSFORMER
- SWITCH MODE POWER SUPPLY

FEATURES:

- LOW THERMAL RESISTANCE
- HIGH INPUT RESISTANCE
- FAST SWITCHING
- ROHS COMPLIANT

MAXIMUM RATINGS (T_c=25°C)

PARAMETER	SYMBOL	VALUE	UNIT
Drain-source Voltage	VDS	100	V
gate-source Voltage	VGS	±20	V
Continuous Drain Current	ID	152	A
Drain Current-Pulsed	IDM	450	A
Total Dissipation	PD	250	W
Junction Temperature	T _j	175	°C
Storage Temperature Range	T _{stg}	-55-175	°C
Single Pulse Avalanche Energy (L=0.3mH)	EAS	600	mJ

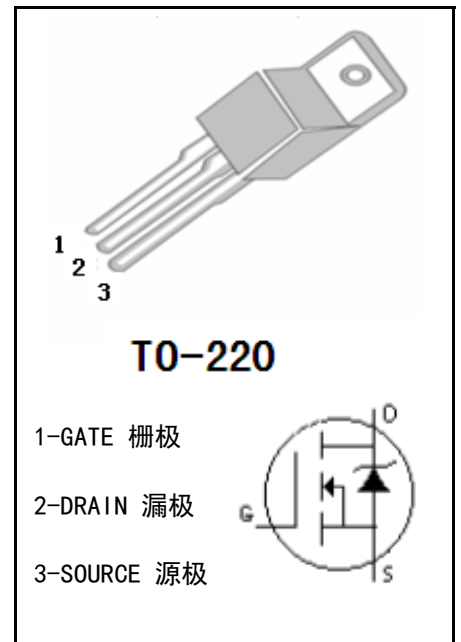
MECHANICAL

ELECTRONIC CHARACTERISTICS (T_c=25°C)

CHARACTERISTICS	SYMBOL	TEST CONDITION	MIN	MAX	UNIT
Drain-source Breakdown Voltage	BVDSS	VGS=0V, ID=250 μA	100		V
Gate Threshold Voltage	VGS (TH)	VGS=VDS, ID=250 μA	2	4	V
Drain-source Leakage Current	IDSS	VDS=100V, VGS=0V		1	uA
Drain-Source Diode Forward Voltage	VSD	VGS=0V, IS=20A		1.2	V
Gate-body Leakage Current (VDS = 0)	IGSS	VGS=±20V		±100	nA
Static Drain-source On Resistance	RDS (ON)	VGS=10V, ID=20A		5	mΩ
Thermal Resistance Junction-case	RthJ-c			0.6	°C/W

■ DYNAMIC CHARACTERISTICS (T_c=25°C)

CHARACTERISTICS	SYMBOL	TEST CONDITION	MIN	TYP	MAX	UNIT
Input Capacitance	C _{iss}	V _{DS} =35V, V _{GS} =0V, f=1.0MHz	-	5200	-	pF
output Capacitance	C _{oss}		-	400	-	pF
Reverse Transfer Capacitance	C _{rss}		-	20	-	pF
Gate resistance	R _G	V _{gsDCBias} =0V, Speed=MED	-	0.7	-	Ω

■ SWITCHING CHARACTERISTICS (T_c=25°C)

CHARACTERISTICS	SYMBOL	TEST CONDITION	MIN	TYP	MAX	UNIT
Turn-On Delay Time	t _{d(on)}	V _{DD} =50V, I _D =20A, V _{GS} =10V, R _G =10Ω	-	20	-	ns
Turn-On Rise Time	t _r		-	12	-	ns
Turn-Off Delay Time	t _{d(off)}		-	65	-	ns
Turn-Off Rise Time	t _f		-	10	-	ns
Total Gate Charge	Q _g	V _{DS} =50V, I _D =20A, V _{GS} =10V	-	61	-	nC
Gate-Source Charge	Q _{gs}		-	20	-	nC
Gate-Drain Charge	Q _{gd}		-	10	-	nC

■ DRAIN-SOURCE DIODE MAXIMUM RATINGS AND CHARACTERISTICS (T_c=25°C)

CHARACTERISTICS	SYMBOL	TEST CONDITION	MIN	TYP	MAX	UNIT
Diode Forward Voltage	V _{SD}	V _{GS} =0V, I _S =20A	-	-	1.2	V
Reverse Recovery Time	t _{rr}	T _J =25°C, I _F =20A, di/dt=500A/μs	-	60	-	ns
Reverse Recovery Charge	Q _{rr}		-	420	-	nC

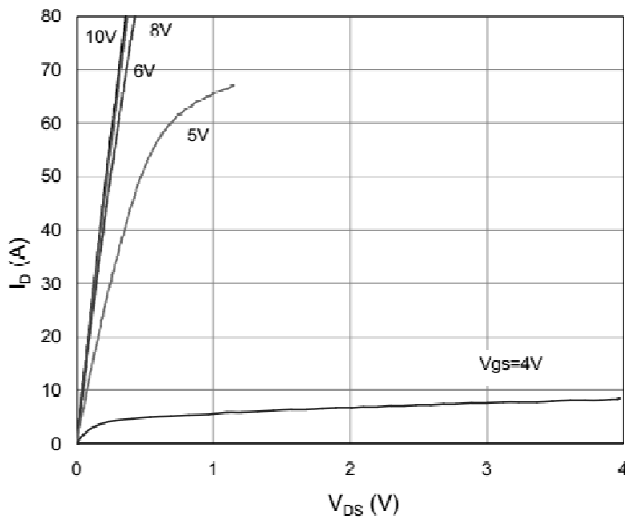
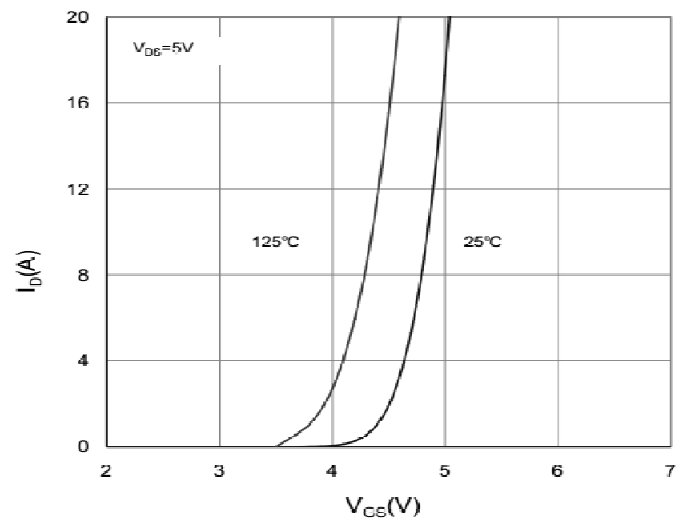
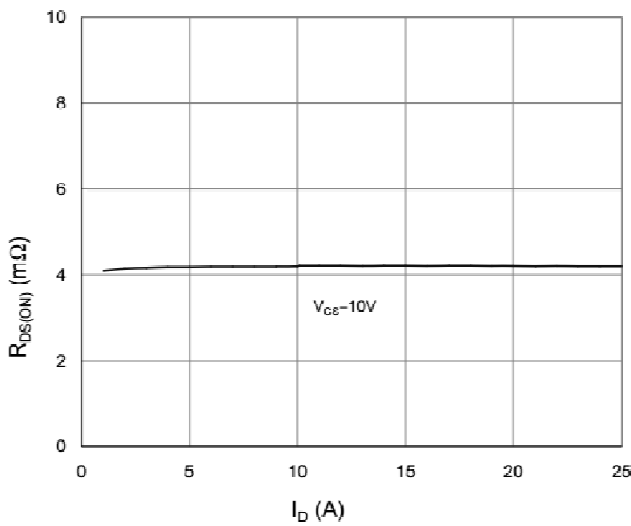
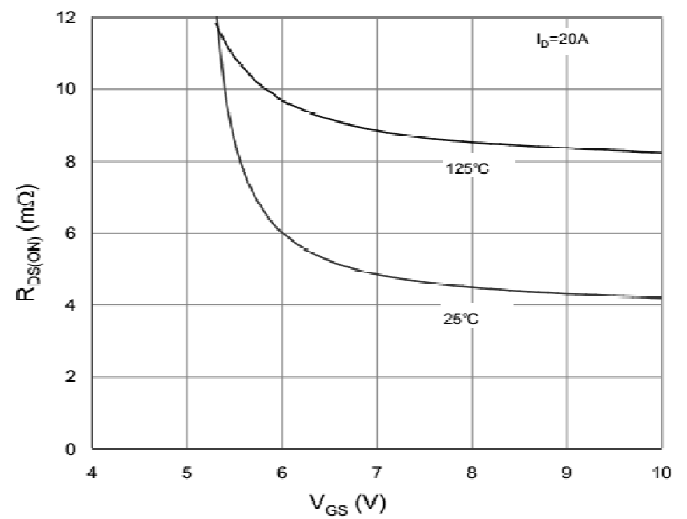
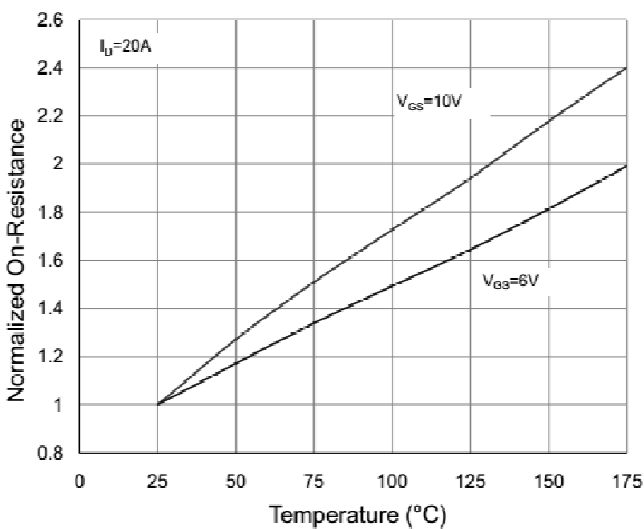
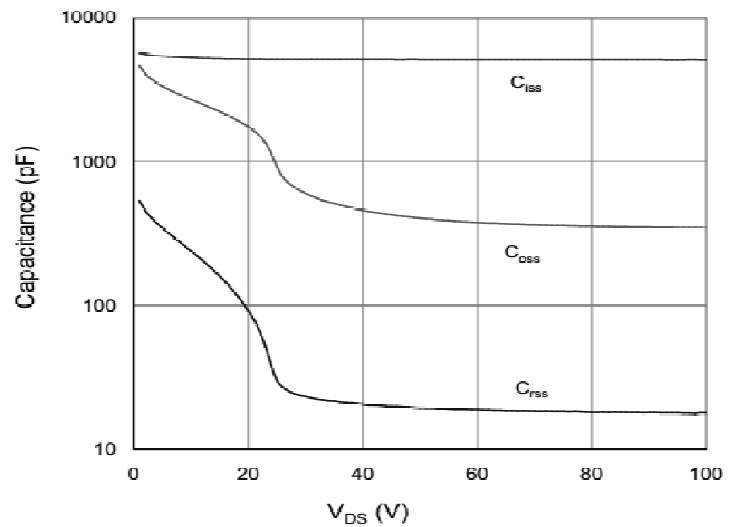
CHARACTERISTICS CURVE

Output Characteristic

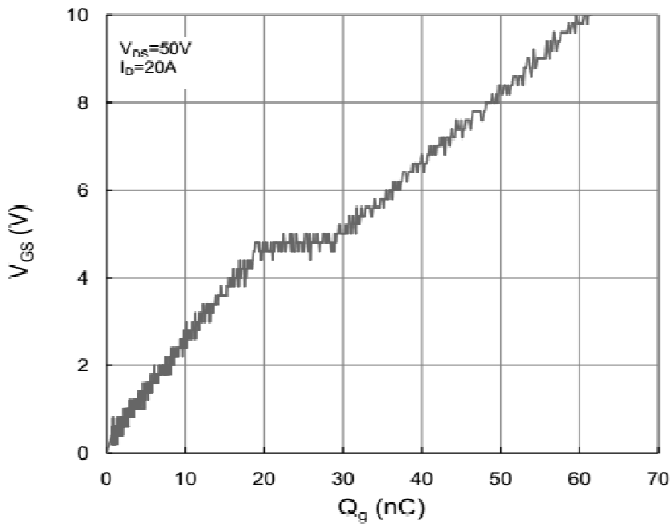
Transfer Characteristic

On Resistance Vs Drain Current

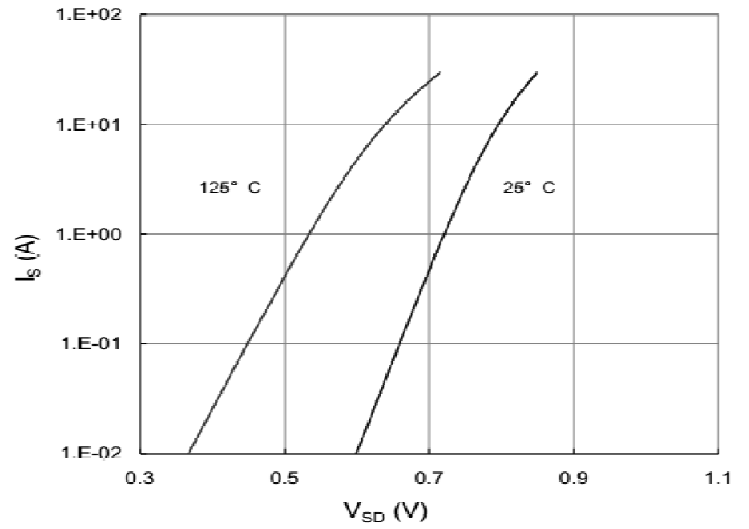
On-Resistance vs. Gate-Source Voltage

On Resistance Vs Junction Temperature

Capacitance

CHARACTERISTICS CURVE



Gate Charge Waveform



Source-Drain Diode Forward Voltage

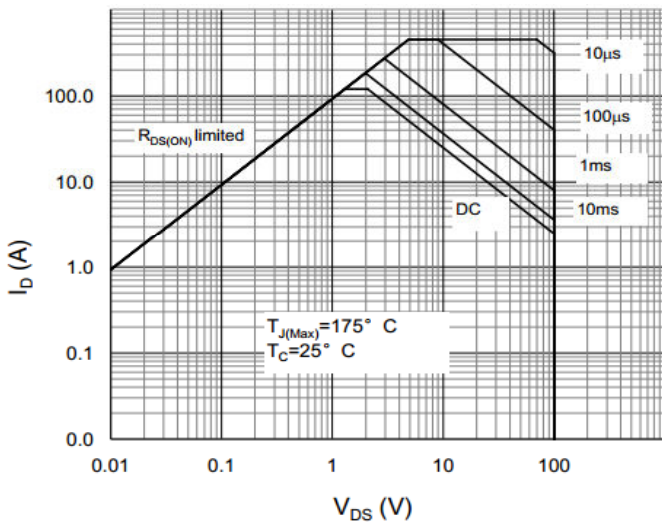

Maximum Safe Operating Area

TO-220 MECHANICAL DATA

UNIT: mm

SYMBOL	MIN	NOM	MAX	SYMBOL	MIN	NOM	MAX
A	4		4.8	e	2.44	2.54	2.64
B	1.2		1.4	F	1.1		1.4
B1	1		1.4	L	12.5		14.5
b1	0.75		0.95	L1	3	3.5	4
c	0.4		0.55	ΦP	3.7	3.8	3.9
D	15		16.5	Q	2.5		3
D1	5.9		6.9	Q1	2		2.9
E	9.9		10.7				

